

EW65

Wheeled Excavators



**WACKER
NEUSON**
all it takes!



Drives itself to the next construction site

The wheeled excavator EW65 drives itself to the site of application thanks to the installed street driving mode and does not require a time and cost-intensive transport. The variable drive system with up to 20 km/h has low fuel consumption and with just one pedal drives almost like a car. The powerful load-sensing hydraulic system with LUDV* (load-independent flow control) also provides for the same speeds of several movements with different loads. With 5 control circuits — of which 3 are individually adjustable — and an articulated boom, the EW65 is very efficient and its way quickly.

- Precise and sensitive operation thanks to the load sensing hydraulic system with LUDV (load-independent flow control)*
- Low consumption due to the economical ECO mode
- Up to 5 auxiliary control circuits for the most varied attachments
- Maintenance and service made easy due to the tiltable cabin as well as the diagnostic tool

EW65 Technical specifications

Operating data

Shipping weight min.	6,472 kg
Operating weight	6,755 - 8,003 kg
Biting force max.	30.8 kN
Breakout force max.	50.7 kN
Digging depth max.	3,895 mm
Dumping height	4,207 - 5,195 mm
Digging radius max.	6,877 mm
Superstructure slewing speed	9 1/min

Engine / Motor

Engine / Motor manufacturer	Perkins
Engine / Motor type	404D-22T
Engine / Motor	water-cooled 4-cylinder turbo diesel engine
Displacement	2,216 cm ³
RPM / speed	2,000 rpm
Engine performance according to ISO	42 kW
Battery	88 Ah
Fuel tank capacity	85 l

Hydraulic system

Duty pump	Variable displacement pump and double hydraulic gear pump
Max. flow rate	144 + 85.5 l/min
Operating pressure drive pump	420 bar
Operating pressure working pump	240 bar
Hydraulic oil tank	92 l

Undercarriage

Tires	mono and dual tires
Track width	300 mm
Ground clearance	237 mm
Travel speed max.	30 km/h

Dozer Blade

Width	2,085 mm
Height	429 mm
Stroke dozer blade above subgrade	395 mm
Stroke dozer blade below subgrade	301 mm

Sound level

Sound level (LwA) according to 2000/14/EC	97 dB(A)
---	----------

EW65 Dimensions

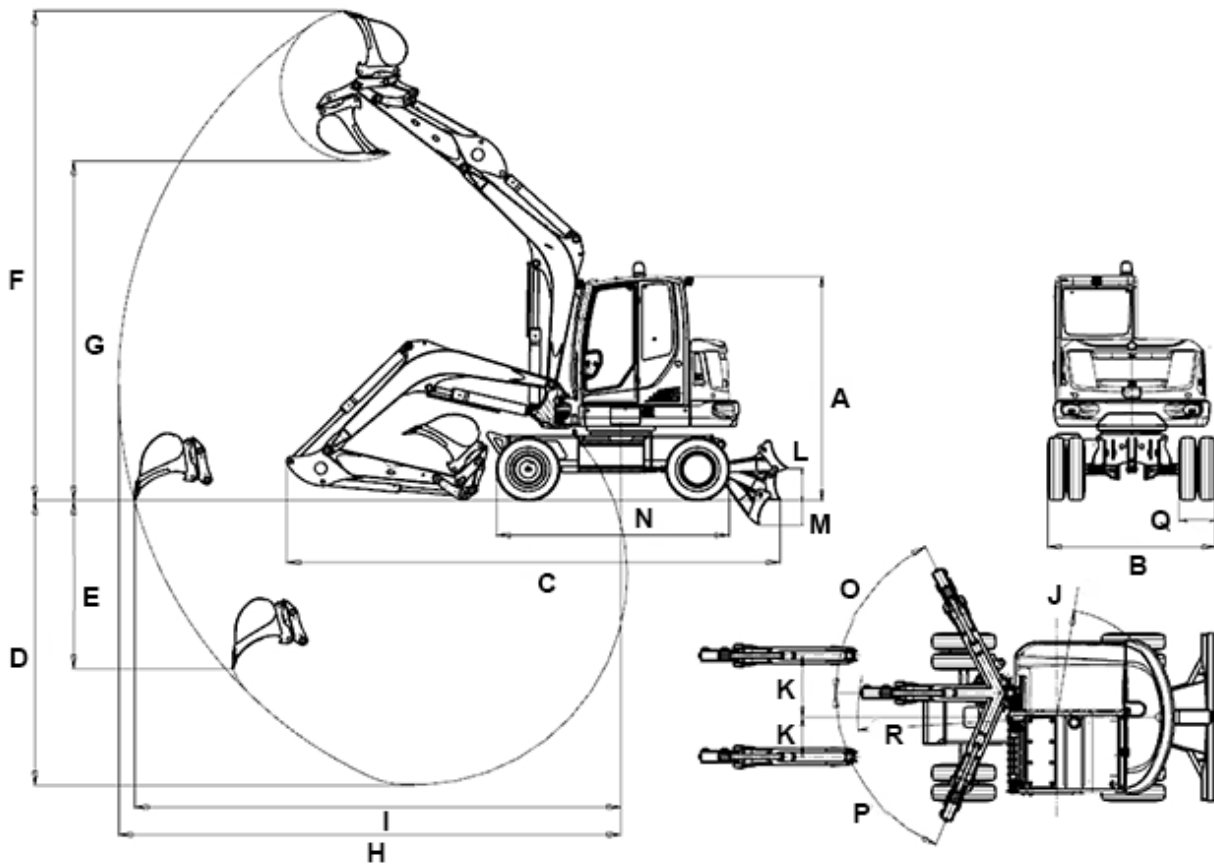

		monobloc boom	articulated boom
A	Height	2,775 mm	2,775 mm
B	Width cabine	1,000 mm	1,000 mm
B	Width revolving superstructure	1,931 mm	1,931 mm
B	Width chassiss with twin tires	2,088 mm	2,088 mm
C	Transport length short ds	6,114 mm	6,220 mm
C	Transport length long ds	6,250 mm	6,349 mm
D	Digging depth max. short ds	3,531 mm	3,596 mm
D	Digging depth max. long ds	3,831 mm	3,895 mm
E	Insertion depth short ds	2,088 mm	2,465 mm
E	Insertion depth long ds	2,361 mm	2,737 mm
F	Insertion height short ds	6,068 mm	6,834 mm
F	Insertion height long ds		7,067 mm
G	Dump height max. short ds	4,207 mm	4,961 mm
G	Dump height max. long ds	4,389 mm	5,195 mm
H	Digging radius max. short ds	6,220 mm	6,590 mm
H	Digging radius max. long ds	6,504 mm	6,877 mm
I	Range on the ground (short ds)	6,024 mm	6,406 mm
I	Range on the ground (long ds)	6,318 mm	6,706 mm
J	Rear swivel radius	1,459 mm	1,459 mm

K	Arm displacement to centre of bucket, right side	766 mm	766 mm
K	Arm displacement to centre of bucket, left side	492 mm	492 mm
L	Lift height above ground	395 mm	395 mm
M	Scraping depth below ground	301 mm	301 mm
N	Length	2,887 mm	2,887 mm
O	Turning angle	63 °	63 °
P	Turning angle	67 °	67 °
Q	Track width	300 mm	300 mm
R	Boom slewing radius center	2,465 mm	2,605 mm
--	Boom slewing radius right	2,393 mm	2,529 mm
--	Boom slewing radius left	1,940 mm	2,073 mm
--	Width chasiss with single tires	1,931 mm	1,931 mm

ds = dipper stick

Please note: that product availability can vary from country to country. It is possible that information / products may not be available in your country. More detailed information on engine power can be found in the operator's manual; the stated power may vary due to specific operating conditions. Subject to alterations and errors excepted. Applicable also to illustrations.

Copyright © 2020 Wacker Neuson SE.